

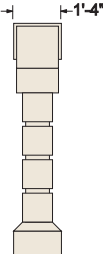

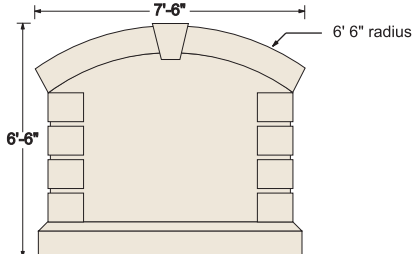







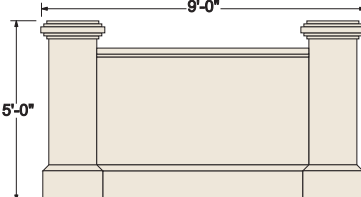

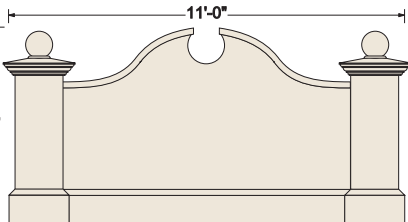

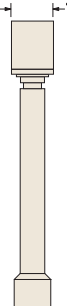
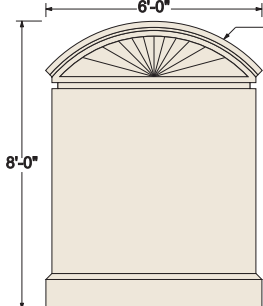

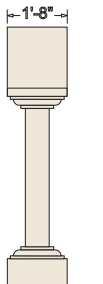
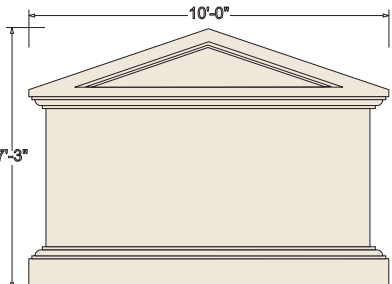
# Standard Models

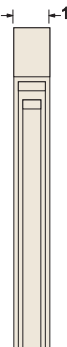
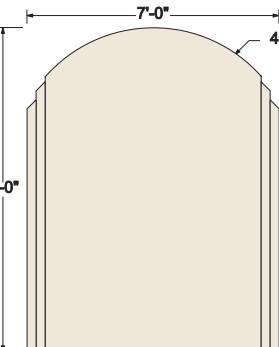
## Drawings #1 thru #8

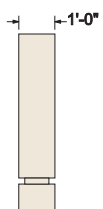
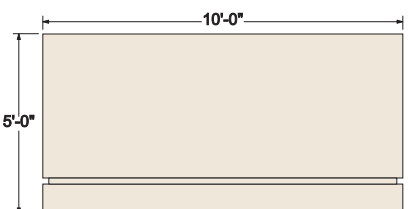
<p>End View</p>  <p>1'-4"</p> <p>Front and Back View</p>  <p>7'-6"</p> <p>6'-6" radius</p> <p>6'-6"</p>  <p>Standard Model #1 Size: 6' 6" x 7' 6" Overall Sq/Ft: 48.75 Date: 5/10/99 Scale: 3/16" = 12"</p>	<p>End View</p>  <p>1'-9"</p> <p>Front and Back View</p>  <p>9'-0"</p> <p>5'-0"</p>  <p>Standard Model #2 Size: 5' 0" x 9' 0" Overall Sq/Ft: 45 Date: 5/10/99 Scale: 3/16" = 12"</p>
<p>End View</p>  <p>1'-4"</p> <p>Front and Back View</p>  <p>5'-6"</p> <p>11'-0"</p>  <p>Standard Model #3 Size: 5' 6" x 11' 0" Overall Sq/Ft: 60.5 Date: 5/10/99 Scale: 3/16" = 12"</p>	<p>End View</p>  <p>1'-2"</p> <p>Front and Back View</p>  <p>6'-0"</p> <p>48" radius</p> <p>8'-0"</p>  <p>Standard Model #4 Size: 8' 0" x 6' 0" Overall Sq/Ft: 48 Date: 5/10/99 Scale: 3/16" = 12"</p>
<p>End View</p>  <p>1'-8"</p> <p>Front and Back View</p>  <p>7'-3"</p> <p>10'-0"</p>  <p>Standard Model #5 Size: 7' 3" x 10' 0" Overall Sq/Ft: 72.5 Date: 5/10/99 Scale: 3/16" = 12"</p>	<p>End View</p>  <p>1'-0"</p> <p>Front and Back View</p>  <p>7'-0"</p> <p>48" radius</p> <p>9'-0"</p>  <p>Standard Model #6 Size: 9' 0" x 7' 0" Overall Sq/Ft: 63 Date: 5/10/99 Scale: 3/16" = 12"</p>
<p>End View</p>  <p>1'-0"</p> <p>Front and Back View</p>  <p>5'-0"</p> <p>10'-0"</p>  <p>Standard Model #7 Size: 5' 0" x 10' 0" Overall Sq/Ft: 50 Date: 5/10/99 Scale: 3/16" = 12"</p>	<p>End View</p>  <p>1'-0"</p> <p>Front and Back View</p>  <p>6'-6"</p> <p>48" radius</p> <p>8'-0"</p>  <p>Standard Model #8 Size: 8' 0" x 6' 6" Overall Sq/Ft: 52 Date: 5/10/99 Scale: 3/16" = 12"</p>

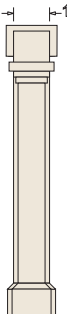
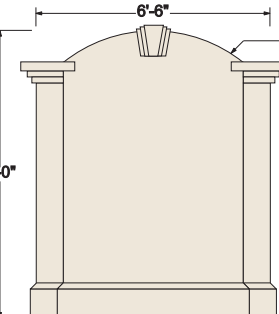
# Standard Models

## Drawings #9 thru #16

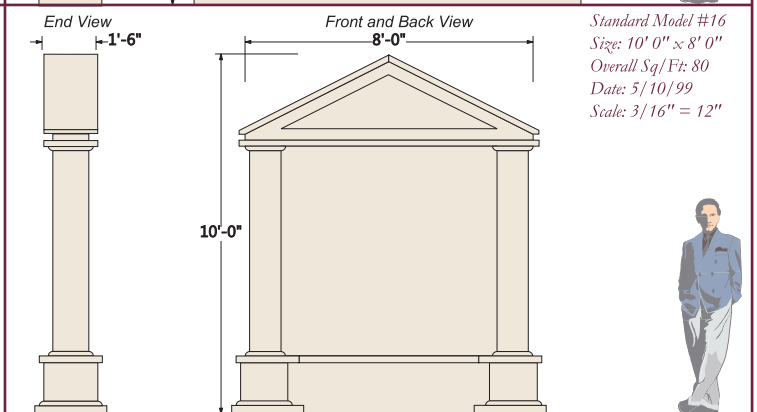
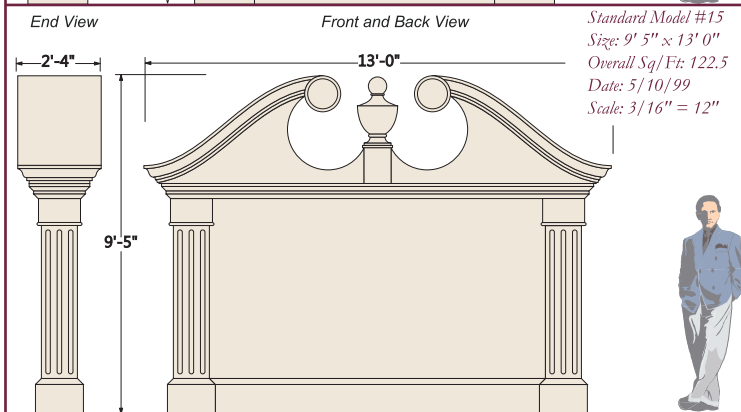
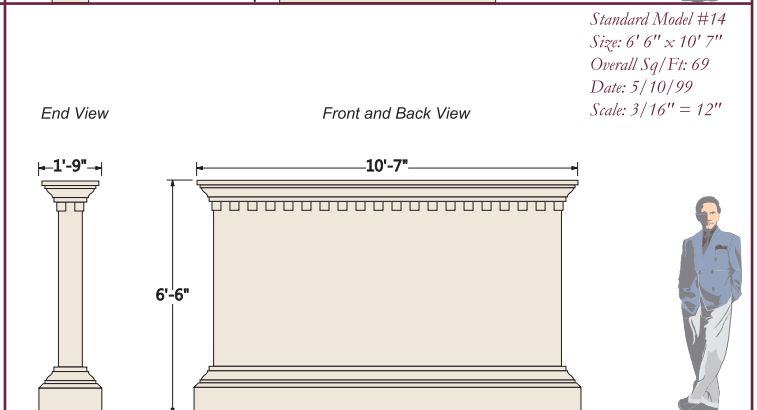
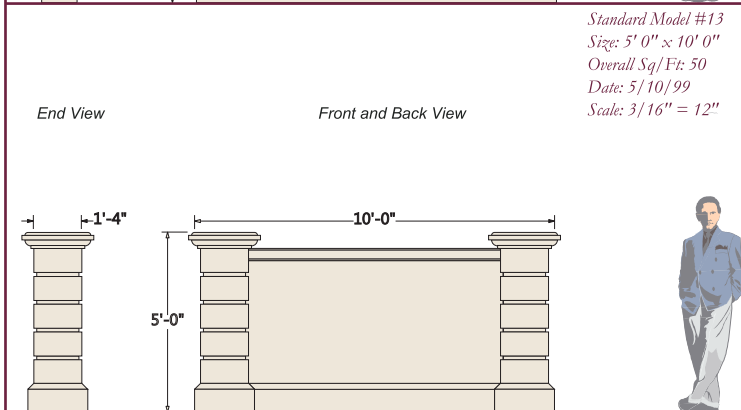
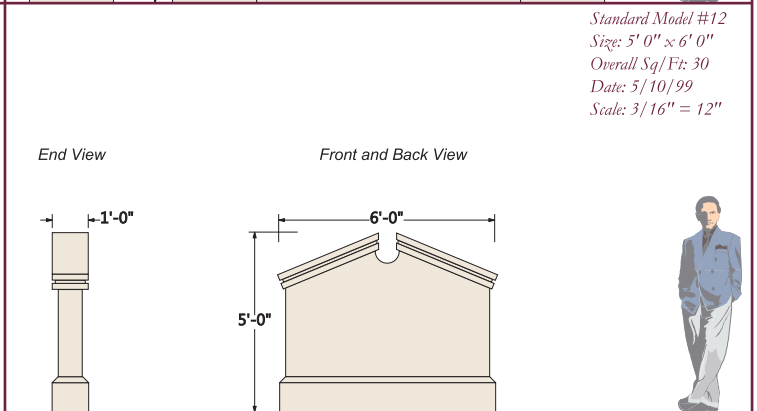
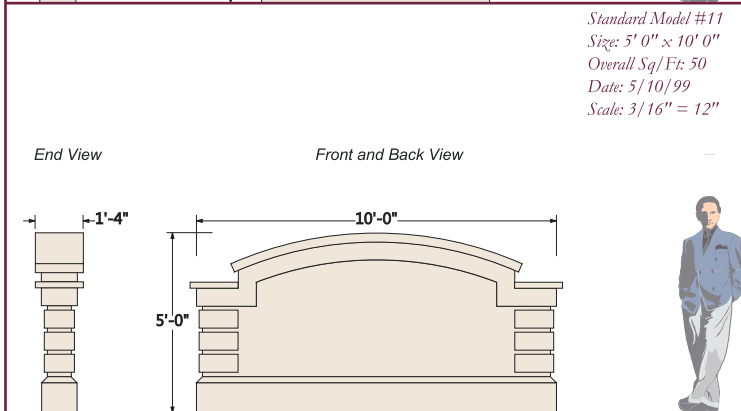
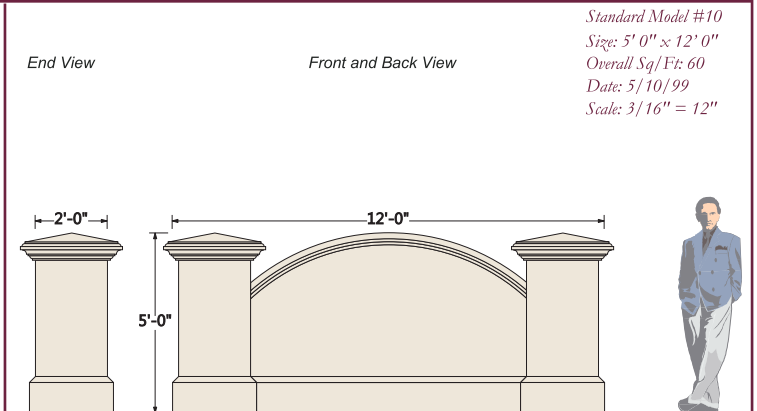
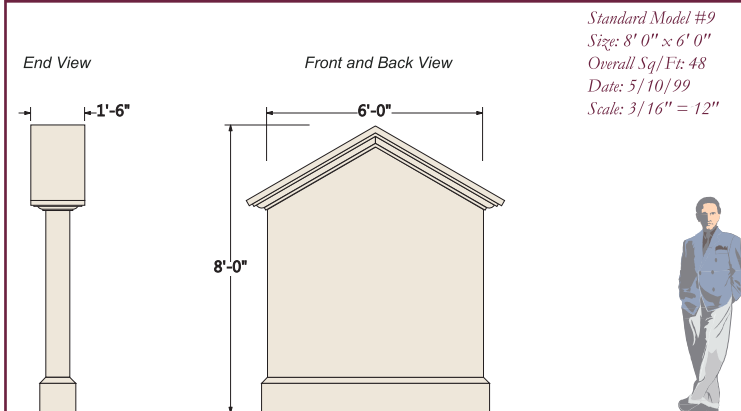

# Standard Models

## Drawings #17 thru #24

**Standard Model #17**  
 Size: 5' 0" x 10' 0"  
 Overall Sq/Ft: 50  
 Date: 5/10/99  
 Scale: 3/16" = 12"

End View

Front and Back View

**Standard Model #18**  
 Size: 6' 0" x 8' 0"  
 Overall Sq/Ft: 48  
 Date: 5/10/99  
 Scale: 3/16" = 12"

End View

Front and Back View

**Standard Model #19**  
 Size: 5' 0" x 10' 0"  
 Overall Sq/Ft: 50  
 Date: 5/10/99  
 Scale: 3/16" = 12"

End View

Front and Back View

**Standard Model #20**  
 Size: 7' 0" x 7' 0"  
 Overall Sq/Ft: 49  
 Date: 5/10/99  
 Scale: 3/16" = 12"

End View

Front and Back View

**Standard Model #21**  
 Size: 5' 0" x 8' 0"  
 Overall Sq/Ft: 40  
 Date: 5/10/99  
 Scale: 3/16" = 12"

End View

Front and Back View

**Standard Model #22**  
 Size: 5' 0" x 10' 0"  
 Overall Sq/Ft: 50  
 Date: 5/10/99  
 Scale: 3/16" = 12"

End View

Front and Back View

**Standard Model #23**  
 Size: 4' 0" x 10' 0"  
 Overall Sq/Ft: 40  
 Date: 5/10/99  
 Scale: 3/16" = 12"

End View

Front and Back View

**Standard Model #24**  
 Size: 5' 7-1/2" x 5' 9"  
 Overall Sq/Ft: 32.5  
 Date: 5/10/99  
 Scale: 3/16" = 12"

End View

Front and Back View

# Standard Models

## Drawings #25 thru #32

<p>End View</p> <p>Front and Back View</p> <p>Standard Model #25 Size: 5'7-1/2" x 7'3" Overall Sq/Ft: 41 Date: 7/31/2002 Scale: 3/16" = 12"</p>	<p>End View</p> <p>Front and Back View</p> <p>Standard Model #26 Size: 5' 7 1/2" x 13' 6" Overall Sq/Ft: 76 Date: 7/31/2002 Scale: 3/16" = 12"</p>
<p>End View</p> <p>Front and Back View</p> <p>Standard Model #27 Size: 5' 7-1/2" x 7' 3" Overall Sq/Ft: 41 Date: 7/31/2002 Scale: 3/16" = 12"</p>	<p>End View</p> <p>Front and Back View</p> <p>Standard Model #28 Size: 5' 4-1/2" x 8' 3" Overall Sq/Ft: 44.35 Date: 7/31/2002 Scale: 3/16" = 12"</p>
<p>End View</p> <p>Front and Back View</p> <p>Standard Model #29 Size: 5' 0" x 8' 0" Overall Sq/Ft: 40 Date: 7/31/2002 Scale: 3/16" = 12"</p>	<p>End View</p> <p>Front and Back View</p> <p>Standard Model #30 Size: 5' 0" x 10' 7" Overall Sq/Ft: 53 Date: 7/31/2002 Scale: 3/16" = 12"</p>
<p>End View</p> <p>Front and Back View</p> <p>Standard Model #31 Size: 5' 4-1/2" x 8' 3" Overall Sq/Ft: 44.35 Date: 7/31/2002 Scale: 3/16" = 12"</p>	<p>End View</p> <p>Front and Back View</p> <p>Standard Model #32 Size: 5' 0" x 6' 0" Overall Sq/Ft: 30 Date: 7/31/2002 Scale: 3/16" = 12"</p>

# Standard Models

## Drawings #33 thru #40

<p>End View</p> <p>Front and Back View</p> <p>Standard Model #33            Size: 5' 0" x 7' 0"            Overall Sq/Ft: 35            Date: 3/19/2003            Scale: 3/16" = 12"</p>	<p>End View</p> <p>Front and Back View</p> <p>Standard Model #34            Size: 6' 0" x 14' 6"            Overall Sq/Ft: 87            Date: 5/19/2003            Scale: 3/16" = 12"</p>
<p>End View</p> <p>Front and Back View</p> <p>Standard Model #35            Size: 4' 7" x 9' 0"            Overall Sq/Ft: 41.25            Date: 5/19/2003            Scale: 3/16" = 12"</p>	<p>End View</p> <p>Front and Back View</p> <p>Standard Model #36            Size: 5' 3" x 8' 7"            Overall Sq/Ft: 45.1            Date: 5/19/2003            Scale: 3/16" = 12"</p>
<p>End View</p> <p>Front and Back View</p> <p>Standard Model #37            Size: 6' 4-1/2" x 7' 0"            Overall Sq/Ft: 44.63            Date: 5/19/2003            Scale: 3/16" = 12"</p>	<p>End View</p> <p>Front and Back View</p> <p>Standard Model #38            Size: 5' 0" x 8' 2"            Overall Sq/Ft: 40.84            Date: 5/19/2003            Scale: 3/16" = 12"</p>
<p>End View</p> <p>Front and Back View</p> <p>Standard Model #39            Size: 6' 0" x 9' 0"            Overall Sq/Ft: 54            Date: 5/19/2003            Scale: 3/16" = 12"</p>	<p>End View</p> <p>Front and Back View</p> <p>Standard Model #40            Size: 6' 4" x 12' 8"            Overall Sq/Ft: 69.67            Date: 5/19/2003            Scale: 3/16" = 12"</p>

# Standard Models

## Drawings #41 thru #48

Standard Model #41  
 Size: 8'4" x 6'1"  
 Overall Sq/Ft: 50.69  
 Date: 1/1/10  
 Scale: NTS

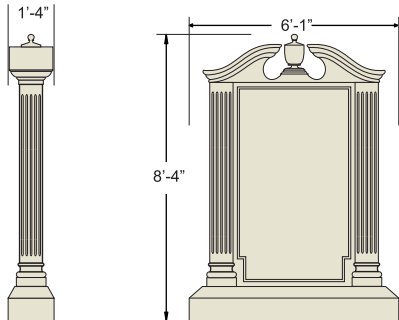

Square Columns

Standard Model #42  
 Size: 5'8" x 7'6"  
 Overall Sq/Ft: 42.5  
 Date: 1/1/10  
 Scale: NTS

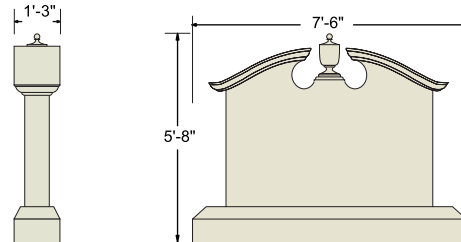

Standard Model #43  
 Size: 6' 0" x 4' 6"  
 Overall Sq/Ft: 27  
 Date: 1/1/10  
 Scale: NTS

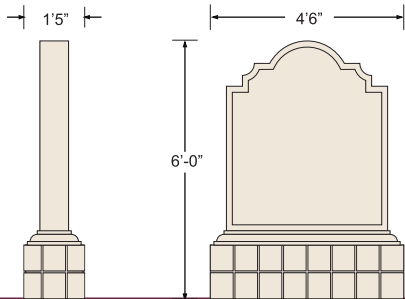

Standard Model #44  
 Size: 8' 0" x 6' 1"  
 Overall Sq/Ft: 48.66  
 Date: 1/1/10  
 Scale: NTS

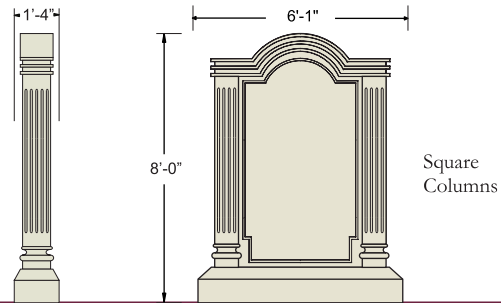

Square Columns

Standard Model #45  
 Size: 5' 6" x 8' 6"  
 Overall Sq/Ft: 46.75  
 Date: 1/1/10  
 Scale: NTS

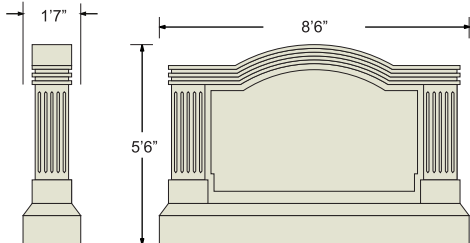

Square Columns

Standard Model #46  
 Size: 5' 7" x 8' 6"  
 Overall Sq/Ft: 47.5  
 Date: 1/1/10  
 Scale: NTS

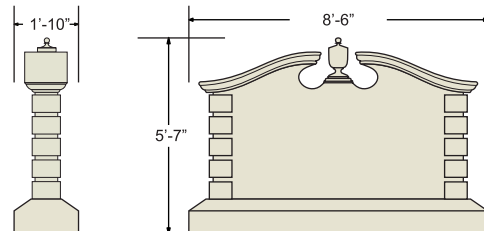

Standard Model #47  
 Size: 7' 0" x 6' 8"  
 Overall Sq/Ft: 46.66  
 Date: 01/01/10  
 Scale: NTS

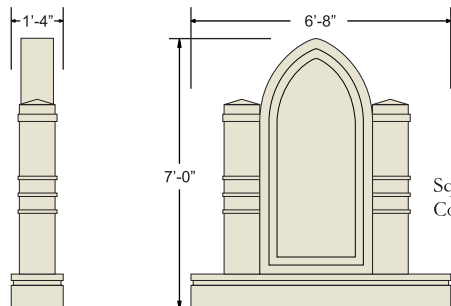

Square Columns

Standard Model #48  
 Size: 7' 6" x 8' 6"  
 Overall Sq/Ft: 68.25  
 Date: 1/1/10  
 Scale: NTS

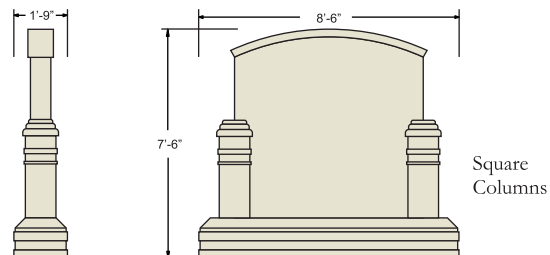

Square Columns

# Standard Models

## Drawings #49 thru #56

Standard Model #49  
 Size: 5'0" x 9'6"  
 Overall Sq/Ft: 47.5  
 Date: 1/01/10  
 Scale: NTS

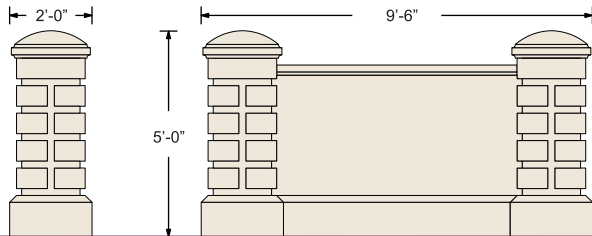

Standard Model #50  
 Size: 4'9" x 4'0"  
 Overall Sq/Ft: 19  
 Date: 1/01/10  
 Scale: NTS

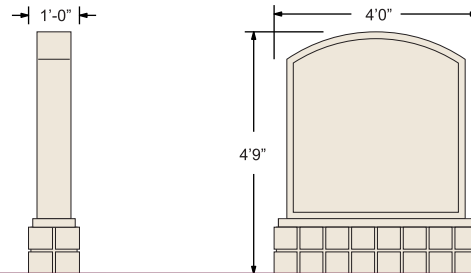

Standard Model #51  
 Size: 4'0" x 6'0"  
 Overall Sq/Ft: 24  
 Date: 1/01/10  
 Scale: NTS

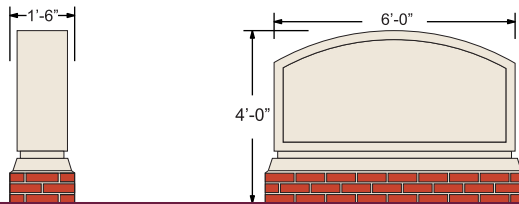

Standard Model #52  
 Size: 5'0" x 8'0"  
 Overall Sq/Ft: 40  
 Date: 1/01/10  
 Scale: NTS

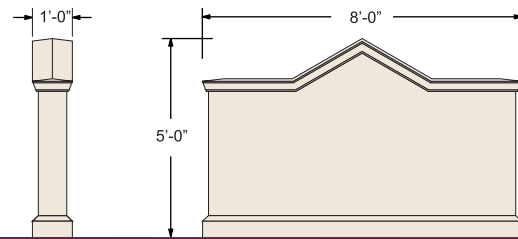

Standard Model #53  
 Size: 5'0" x 10'0"  
 Overall Sq/Ft: 50  
 Date: 1/01/10  
 Scale: NTS

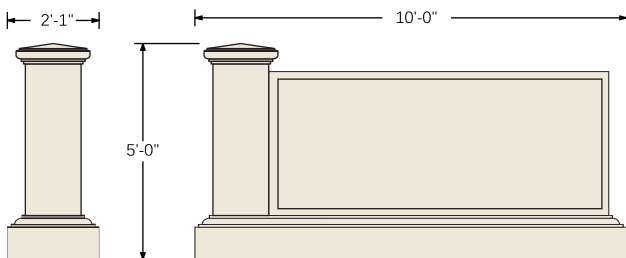

Standard Model #54  
 Size: 5'0" x 9'0"  
 Overall Sq/Ft: 45  
 Date: 1/01/10  
 Scale: NTS

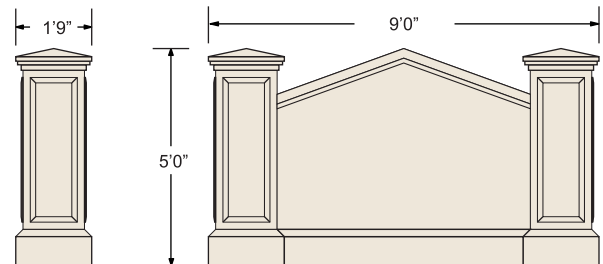

Standard Model #55  
 Size: 6'8" x 5'0"  
 Overall Sq/Ft: 33.33  
 Date: 1/01/10  
 Scale: NTS

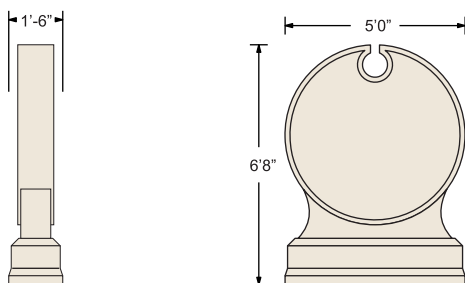

Standard Model #56  
 Size: 6'8" x 5'0"  
 Overall Sq/Ft: 33.33  
 Date: 01/1/10  
 Scale: NTS

